

Panasonic[®]

5.8 GHz Expandable Digital Cordless Handset

Model No. **KX-TGA450**

Installation Manual

PLEASE READ BEFORE USE AND SAVE.

This handset is an accessory cordless handset for use with the Panasonic KX-TG4500. This installation manual only describes the steps necessary to start up the handset. Please read the KX-TG4500 Operating Instructions for further details.

Accessories (included). For extra orders, call 1-800-332-5368.

<input type="checkbox"/> Charger Unit1 Charger Order No. PQLV30046ZA AC Adaptor Order No. PQLV256Z	<input type="checkbox"/> Cordless Handset Battery1 Order No. HHR-P104
<input type="checkbox"/> Handset Battery Cover1 Order No. PQYNTG4500BR	<input type="checkbox"/> Belt Clip1 Order No. PQKE10377Z5

Installation

Connecting the Charger unit

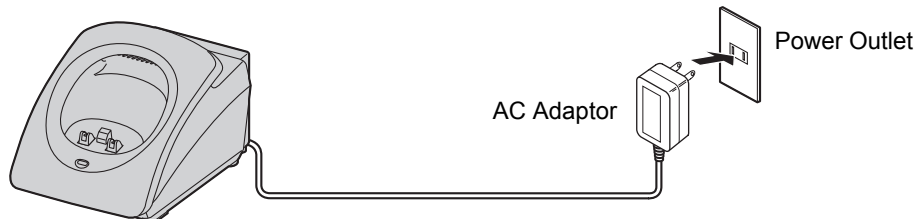

- Use only the included Panasonic AC Adaptor PQLV256 (Order No. PQLV256Z).
- The AC adaptor must remain connected at all times. (It is normal for the adaptor to feel warm during use.)
- The AC adaptor should be connected to a vertically oriented or floor-mounted AC outlet. Do not connect the AC adaptor to a ceiling-mounted AC outlet, as the weight of the adaptor may cause it to disconnect.

Installing the battery

Insert the battery, and press it down until it fits in position with the compartment. Close the cover.

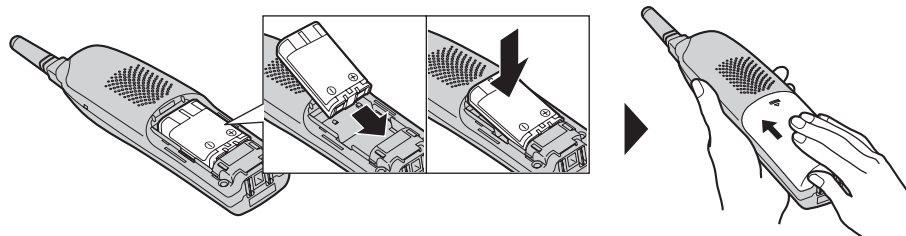

For assistance, please visit <http://www.panasonic.com/phonehelp>

Registration

This cordless handset must be registered to a KX-TG4500 base unit. The handset will be assigned the next available extension number at registration. Only one handset can be registered at a time. **Charge the battery fully. Make sure that the base unit and other handsets are not being used. Have both the handset and base unit nearby during registration.**

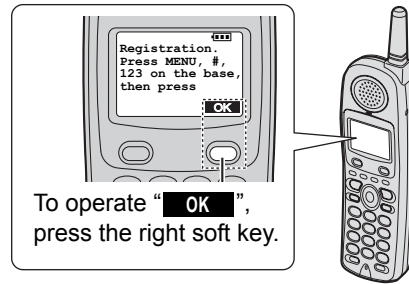

The handset display shows the instructions as shown on the right.

Registration.
Press MENU, #,
123 on the base,
then press
OK

1 Base unit: Press **[MENU]**, followed by **[#]**, **[1]**, **[2]**, **[3]** and **[ENTER]**.

2 Handset:

(1) Press **OK**.

(2) Confirmation tone is heard and the display shows the new extension number.

- Registration is complete.

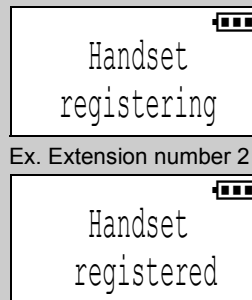

To cancel handset registration, please see the KX-TG4500 Operating Instructions.

For assistance, please visit <http://www.panasonic.com/phonehelp>

Selecting the display language

You can select either "English" or "Spanish" as the display language. The factory preset is "English".

Press **[MENU]** → **[▼]** or **[▲]** to select "Initial setting" → **Select** → **[▼]** or **[▲]** to select "Change language" → **Select** → **[▼]** or **[▲]** to select "Español" or "English" → **Save**.

Optional Headset

Connecting an optional headset to the handset allows a hands-free phone conversation. Please use only a Panasonic KX-TCA86 headset. To order, call the accessories telephone number shown on page 1.

Connecting an optional headset

Open the headset jack cover, and insert the headset plug into the headset jack as shown below.

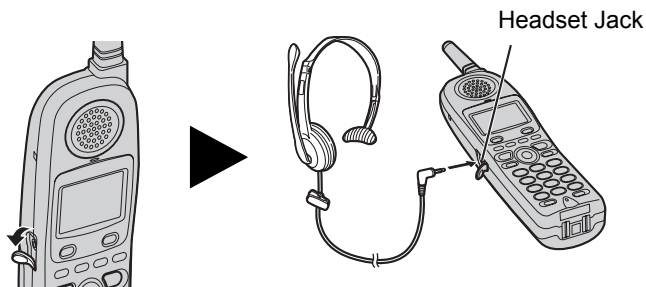

- Headset sold separately.

Wall Mounting

The charger can be wall mounted. Connect the AC adaptor. Install screws using the wall template (see below). Mount the charger (1). Slide it down (2), then slide down to the right (3) until it is secured.

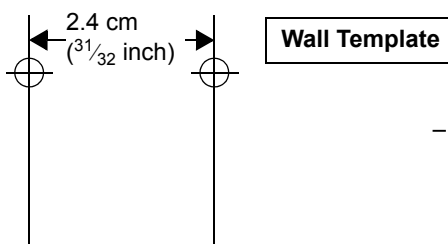
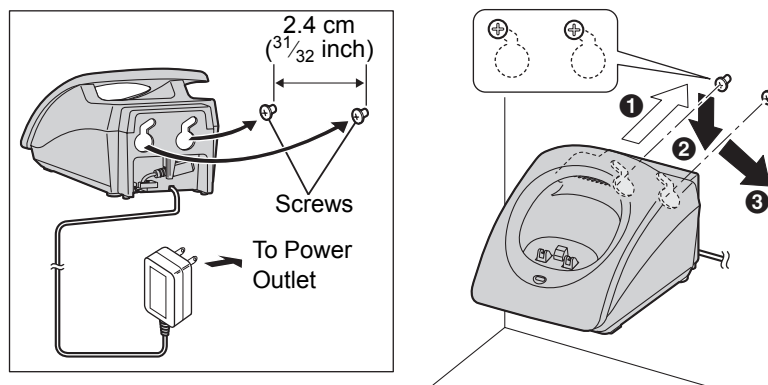

FCC and Other Information

WHEN PROGRAMMING EMERGENCY NUMBERS AND (OR) MAKING TEST CALLS TO EMERGENCY NUMBERS:

1. Remain on the line and briefly explain to the dispatcher the reason for the call.
2. Perform such activities in the off-peak hours, such as early morning or late evenings.

This device complies with Part 15 of the FCC Rules. Operation is subject to the following two conditions: (1) This device may not cause harmful interference, and (2) this device must accept any interference received, including interference that may cause undesired operation.

Privacy of communications may not be ensured when using this phone.

CAUTION:

Any changes or modifications not expressly approved by the party responsible for compliance could void the user's authority to operate this device.

Note:

This equipment has been tested and found to comply with the limits for a Class B digital device, pursuant to Part 15 of the FCC Rules. These limits are designed to provide reasonable protection against harmful interference in a residential installation. This equipment generates, uses, and can radiate radio frequency energy and, if not installed and used in accordance with the instructions, may cause harmful interference to radio communications. However, there is no guarantee that interference will not occur in a particular installation. If this equipment does cause harmful interference to radio or television reception, which can be determined by turning the equipment off and on, the user is encouraged to try to correct the interference by one or more of the following measures:

- Reorient or relocate the receiving antenna.
- Increase the separation between the equipment and receiver.
- Connect the equipment into an outlet on a circuit different from that to which the receiver is connected.
- Consult the dealer or an experienced radio/TV technician for help.

Operating the product near 5.8 GHz electrical appliances may cause interference. Move away from the electrical appliances.

FCC RF Exposure Warning:

To comply with FCC RF exposure requirements, the handset unit may be carried and operated with only the specific provided belt-clip. Other non-tested belt-clips or similar body-worn accessories may not comply and must be avoided.

This equipment is hearing aid compatible as defined by the FCC in 47 CFR Section 68.316.

When you hold the phone to your ear, noise might be heard in your Hearing Aid. Some Hearing Aids are not adequately shielded from external RF (radio frequency) energy. If noise occurs, use an optional headset accessory or the speakerphone option (if applicable) when using this phone. Consult your audiologist or Hearing Aid manufacturer about the availability of Hearing Aids which provide adequate shielding to RF energy commonly emitted by digital devices.

For assistance, please visit <http://www.panasonic.com/phonehelp>

CAUTION:

To reduce the risk of fire or injury to persons, read and follow these instructions.

1. Use only the battery(ies) specified.
2. Do not dispose of the battery(ies) in a fire. They may explode. Check with local waste management codes for special disposal instructions.
3. Do not open or mutilate the battery(ies). Released electrolyte is corrosive and may cause burns or injury to the eyes or skin. The electrolyte may be toxic if swallowed.
4. Exercise care in handling batteries in order not to short the battery to conductive materials such as rings, bracelets, and keys. The battery and/or conductor may overheat and cause burns.
5. Charge the battery(ies) provided with or identified for use with this product only in accordance with the instructions and limitations specified in this manual.

A nickel metal hydride battery that is recyclable powers the product you have purchased. Please call 1-800-8-BATTERY (1-800-822-8837) for information on how to recycle this battery.



WARNING:

TO PREVENT FIRE OR SHOCK HAZARD, DO NOT EXPOSE THIS PRODUCT TO RAIN OR ANY TYPE OF MOISTURE.

- The AC adaptor is used as the main disconnect device. Ensure that the AC outlet is installed near the product and is easily accessible.

For your future reference

Serial No. _____

Date of purchase _____

(found on the bottom of the unit)

Name and address of dealer _____

If you need assistance with setup or operation:

- 1 Visit our website: <http://www.panasonic.com/phonehelp>
- 2 Contact us via the web at: <http://www.panasonic.com/contactinfo>
- 3 Call us at: 1-800-211-PANA (1-800-211-7262)
TTY users (hearing or speech impaired users) can call 1-877-833-8855.

Copyright:

This material is copyrighted by Panasonic Communications Co. (U.K.) Ltd., and may be reproduced for internal use only. All other reproduction, in whole or in part, is prohibited without the written consent of Panasonic Communications Co. (U.K.) Ltd.

© 2006 Panasonic Communications Co. (U.K.) Ltd. All Rights Reserved.

**Panasonic Consumer Electronics Company,
Division of Panasonic Corporation of North America**

One Panasonic Way, Secaucus, New Jersey 07094

Panasonic Puerto Rico, Inc.

San Gabriel Industrial Park, Ave. 65 de Infantería, Km. 9.5,
Carolina, Puerto Rico 00985

PANASONIC CONSUMER
ELECTRONICS COMPANY, DIVISION
OF PANASONIC CORPORATION OF
NORTH AMERICA
One Panasonic Way,
Secaucus, New Jersey 07094

PANASONIC PUERTO RICO, INC.
San Gabriel Industrial Park,
Ave. 65 de Infantería, Km. 9.5,
Carolina, Puerto Rico 00985

Panasonic Telephone Products Limited Warranty

Limited Warranty Coverage

If your product does not work properly because of a defect in materials or workmanship, Panasonic Consumer Electronics Company or Panasonic Puerto Rico, Inc. (collectively referred to as "the warrantor") will, for the length of the period indicated on the chart below, which starts with the date of original purchase ("Limited Warranty period"), at its option either (a) repair your product with new or refurbished parts, or (b) replace it with a new or a refurbished product. The decision to repair or replace will be made by the warrantor.

Parts	Labor
One (1) Year	One (1) Year

During the "Labor" Limited Warranty period there will be no charge for labor. During the "Parts" Limited Warranty period, there will be no charge for parts. You must mail-in your product prepaid during the Limited Warranty period. This Limited Warranty excludes both parts and labor for batteries, antennas, and cosmetic parts (cabinet). This Limited Warranty only applies to products purchased and serviced in the United States or Puerto Rico. This Limited Warranty is extended only to the original purchaser and only covers products purchased as new.

Mail-In Service

For assistance in the continental U.S.A. in obtaining repairs please ship the product prepaid to:

Panasonic Services Company Customer Servicenter
4900 George McVay Drive Suite B Door #12 McAllen, TX 78503

For assistance in Puerto Rico call Panasonic Puerto Rico, Inc. (787)-750-4300 or fax (787)-768-2910.

For Limited Warranty service for headsets if a headset is included with this product please call Panasonic Call Center at 1-800-211-PANA (1-800-211-7262).

When shipping the unit carefully pack, include all accessories, and send it prepaid, adequately insured and preferably in the original carton. Include a letter detailing the complaint and provide a day time phone number where you can be reached.

IF REPAIR IS NEEDED DURING THE LIMITED WARRANTY PERIOD THE PURCHASER WILL BE REQUIRED TO FURNISH A SALES RECEIPT/PROOF OF PURCHASE INDICATING DATE OF PURCHASE, AMOUNT PAID AND PLACE OF PURCHASE. CUSTOMER WILL BE CHARGED FOR THE REPAIR OF ANY UNIT RECEIVED WITHOUT SUCH PROOF OF PURCHASE.

Limited Warranty Limits And Exclusions

This Limited Warranty ONLY COVERS failures due to defects in materials or workmanship, and DOES NOT COVER normal wear and tear or cosmetic damage. The Limited Warranty ALSO DOES NOT COVER damages which occurred in shipment, or failures which are caused by products not supplied by the warrantor, or failures which result from accidents, misuse, abuse, neglect, bug infestation, mishandling, misapplication, alteration, faulty installation, set-up adjustments, misadjustment of consumer controls, improper maintenance, power line surge, lightning damage, modification, introduction of sand, humidity or liquids, or rental use of the product, or service by anyone other than a Factory Servicenter or other Authorized Servicer, or damage that is attributable to acts of God.

THERE ARE NO EXPRESS WARRANTIES EXCEPT AS LISTED UNDER "LIMITED WARRANTY COVERAGE". THE WARRANTOR IS NOT LIABLE FOR INCIDENTAL OR CONSEQUENTIAL DAMAGES RESULTING FROM THE USE OF THIS PRODUCT, OR ARISING OUT OF ANY BREACH OF THIS LIMITED WARRANTY. (As examples, this excludes damages for lost time, lost calls or messages, cost of having someone remove or re-install an installed unit if applicable, travel to and from the servicer. The items listed are not exclusive, but are for illustration only.) **ALL EXPRESS AND IMPLIED WARRANTIES, INCLUDING THE WARRANTY OF MERCHANTABILITY, ARE LIMITED TO THE PERIOD OF THE LIMITED WARRANTY.**

Some states do not allow the exclusion or limitation of incidental or consequential damages, or limitations on how long an implied warranty lasts, so the exclusions may not apply to you. This Limited Warranty gives you specific legal rights and you may also have other rights which vary from state to state. If a problem with this product develops during or after the Limited Warranty period, you may contact your dealer or Servicenter. If the problem is not handled to your satisfaction, then write to the warrantor's Consumer Affairs Department at the addresses listed for the warrantor.

PARTS AND SERVICE, WHICH ARE NOT COVERED BY THIS LIMITED WARRANTY, ARE YOUR RESPONSIBILITY.

Customer Services Directory

Obtain Product Information and Operating Assistance; locate your nearest Dealer or Servicenter; purchase Parts and Accessories; or make Customer Service and Literature requests by visiting our Web Site at:

<http://www.panasonic.com/phonehelp>

or, contact us via the web at:

<http://www.panasonic.com/contactinfo>

You may also contact us directly at: 1-800-211-PANA (1-800-211-7262), Monday-Friday 9 am-9 pm; Saturday-Sunday 10 am-7 pm, EST.

TTY users (hearing or speech impaired users) can call 1-887-833-8855.

Accessory Purchases

Purchase Parts, Accessories and Instruction Books online for all Panasonic Products by visiting our Web Site at:

<http://www.pasc.panasonic.com>

or, send your request by E-mail to:

npcparts@us.panasonic.com

You may also contact us directly at:

1-800-332-5368 (Phone) 1-800-237-9080 (Fax Only)

(Monday - Friday 9 am to 9 pm, EST.)

Panasonic Services Company

20421 84th Avenue South, Kent, WA 98032

(We Accept Visa, MasterCard, Discover Card, American Express, and Personal Checks)

TTY users (hearing or speech impaired users) can call 1-866-605-1277.

Service in Puerto Rico

Panasonic Puerto Rico, Inc.

San Gabriel Industrial Park, Ave. 65 de Infantería, Km. 9.5,

Carolina, Puerto Rico 00985

Phone (787)750-4300, Fax (787)768-2910

Selección del idioma de la pantalla

Puede seleccionar "English" (Inglés) o "Español" como el idioma de la pantalla. El idioma preconfigurado en fábrica es "English" (Inglés).
 Presione [MENU] ◀ [▼] o [▲] para seleccionar "Initial setting" ▶ Select ▶ [▼] o [▲] para seleccionar "Change Language" ▶ Select ▶ [▼] o [▲] para seleccionar "Español", o "English" ▶ Save.

Auricular opcional

La conexión de un auricular opcional a la unidad portátil permite conversar telefónicamente con las manos libres. Por favor, utilice solamente un auricular KX-TCA86 de Panasonic.
 Para hacer un pedido, llame al número de teléfono de accesorios indicado en la página (1).

Conexión de un auricular opcional

Abra la cubierta de la toma del auricular, e inserte allí la clavija del auricular dentro la toma del auricular como se indica abajo.

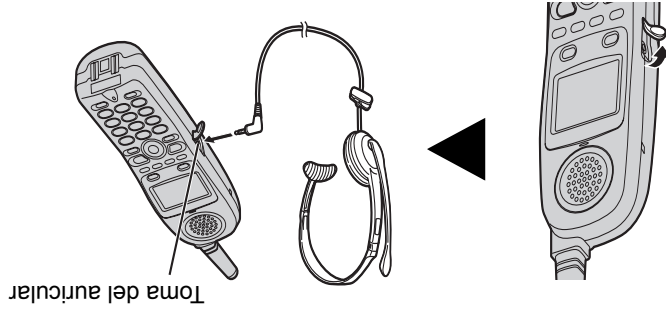

• El auricular se vende por separado.

Montaje en pared

La unidad de carga se puede montar en la pared. Conecte el adaptador de CA. Introduzca los tornillos usando la plantilla de pared (ver abajo). Monte la unidad de carga (1). Deslicela hacia abajo (2), luego deslicela hacia abajo y a la derecha (3) hasta que quede bien sujeta.

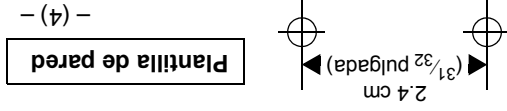
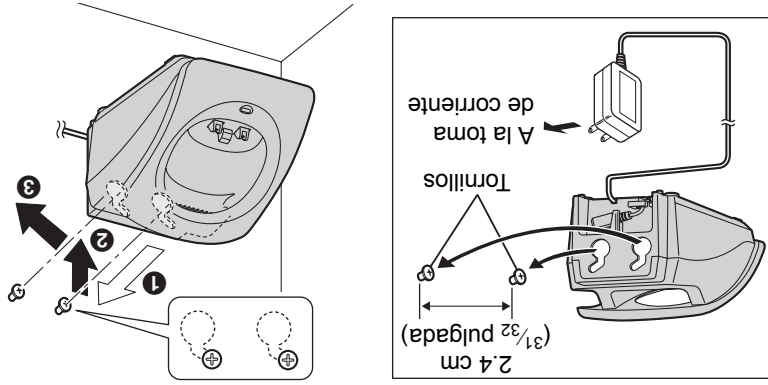

Registro

Esta unidad portátil debe registrarse en una unidad base KX-TG4500. A la unidad portátil se le asignará su número de extensión al registrarla. Sólo podrá registrarse una unidad portátil por vez. **Cargue la batería completamente. Asegúrese de que la unidad base y las demás unidades portátiles no se están utilizando. Tenga a mano tanto la unidad portátil como la unidad base durante el registro.**

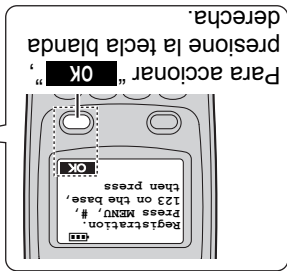
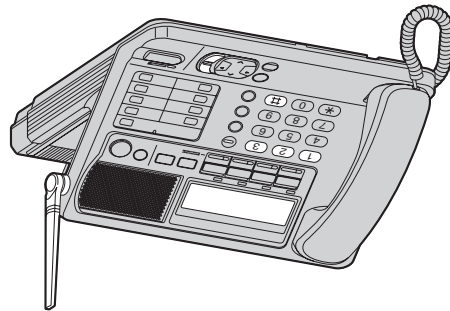

La pantalla de la unidad portátil muestra las instrucciones tal y como aparecen a la derecha.

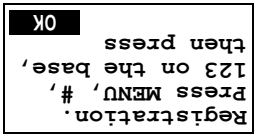

1 Unidad base: Pulse [MENU], y luego [#], [1], [2], [3] y [ENTER].

2 Unidad portátil:

(1) Presione [OK].

(2) Se escuchará un tono de confirmación y el visor mostrará el nuevo número de extensión.

- El registro ha finalizado.

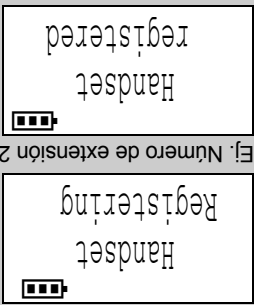

Para cancelar el registro, por favor vea las Instrucciones de Operación del equipo KX-TG4500.

Manual de instalación

LÉALO ANTES DE LA UTILIZACIÓN Y LUEGO GUÁRDALO.

Esta unidad portátil es un accesorio inalámbrico para uso con el equipo Panasonic KX-TG4500. Este manual de instalación sólo describe los pasos necesarios para poner en funcionamiento la unidad portátil. Para obtener más informaciones por favor lea las instrucciones de operación del equipo KX-TG4500.

Accesorios (incluidos) Para más pedidos, llame al 1-800-332-5368.

- Unidad de carga. 1
- Bateria. 1
- Nº. de pedido: HHR-P104
- Presilla para el cinturón. 1
- Nº. de pedido: PQKE1037725
- Nº. de pedido del adaptador de CA: PQLV256Z
- Cubierta de la unidad portátil. 1
- Nº. de pedido: PQYNTG4500BR

Instalación

Conecte la unidad de carga

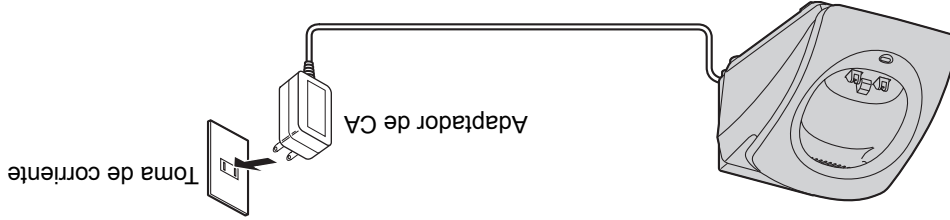

- Usar sólo con el adaptador de ca PQLV256 (Nº. de pedido: PQLV256Z) de Panasonic.
- El adaptador de CA debe permanecer conectado en todo momento. (Es normal que el adaptador se caliente durante su uso.)

Instalación de la batería

Inserte la batería y presione hasta que calce dentro del compartimento. Cierre la cubierta.

