

Panasonic®

Advanced Hybrid System

User Guide for KX-T77 Series



Model No. **KX-TA824**







































Please read this guide before using and save for future reference.

Document Version: 2006-05

























Features List

 Outside (CO) Line button  Programmable Feature button  Feature number



 Off-hook  On-hook  Talk * "Location of Controls" is shown on pages 8-9.

Desired Feature	Operation
Making Calls	
Calling	<p>To an extension</p>  ►  / extension no. ► 
	<p>To an external party</p>  ►  ► phone no. ► 
Redial	 ►  ► 
One-touch Dialing	<p>To program</p>  ►  2 /  ► desired no. ►  ► 
	<p>To dial</p>  ►  /  ► 
Calling an operator	 ►  ► 
Speed Dialing (Personal)	<p>To store</p>  ►  * ► personal speed dial no. (0-9) ► desired no. ►  ► 
	<p>To dial</p>  ►  ► personal speed dial no. (0-9) ► 
Speed Dialing (System)	<p>To dial</p>  ►  ► system speed dial no. (00-99) ► 
Receiving Calls	
Hands-free answerback (Other than KX-T7750)	<p><i>While on-hook</i></p> 
Picking up a call	<p>Directed</p>  ►  ► extension no. ► 
	<p>Group</p>  

Features List

Desired Feature	Operation																								
When the Dialed Extension is Busy/No Answer																									
Automatic Callback Busy	To set <i>While hearing a busy tone</i>  ► 	To call <i>If you hear callback ringing</i> 																							
Message Waiting	Sender	To leave a notification  ►  <hr/> To cancel a notification  ► receiver's extension no. ►  ►  ► 																							
	Receiver	To call back  ►  ►  <hr/> To clear all notifications  ► 7 0 0 ► # ► 																							
Call Waiting	Sender	<i>While hearing a busy tone</i> 1 ► Wait for an answer. ► 																							
	Receiver	 ► <div style="border: 1px dashed black; padding: 10px; display: inline-block; margin: 10px;"> <p>For outside calls</p> <table style="border-collapse: collapse;"> <tr> <td style="border: 1px solid black; padding: 2px;">7</td> <td style="border: 1px solid black; padding: 2px;">3</td> <td style="border: 1px solid black; padding: 2px;">1</td> <td style="border: 1px solid black; padding: 2px;">1</td> <td style="border: 1px solid black; padding: 2px;">#</td> <td style="padding-left: 5px;">Set</td> </tr> <tr> <td style="border: 1px solid black; padding: 2px;">7</td> <td style="border: 1px solid black; padding: 2px;">3</td> <td style="border: 1px solid black; padding: 2px;">1</td> <td style="border: 1px solid black; padding: 2px;">0</td> <td style="border: 1px solid black; padding: 2px;">#</td> <td style="padding-left: 5px;">Cancel</td> </tr> </table> <p>For intercom calls/doorphone calls</p> <table style="border-collapse: collapse;"> <tr> <td style="border: 1px solid black; padding: 2px;">7</td> <td style="border: 1px solid black; padding: 2px;">3</td> <td style="border: 1px solid black; padding: 2px;">2</td> <td style="border: 1px solid black; padding: 2px;">1</td> <td style="border: 1px solid black; padding: 2px;">#</td> <td style="padding-left: 5px;">Set</td> </tr> <tr> <td style="border: 1px solid black; padding: 2px;">7</td> <td style="border: 1px solid black; padding: 2px;">3</td> <td style="border: 1px solid black; padding: 2px;">2</td> <td style="border: 1px solid black; padding: 2px;">0</td> <td style="border: 1px solid black; padding: 2px;">#</td> <td style="padding-left: 5px;">Cancel</td> </tr> </table> </div>  ► <hr/> To talk to the new party <i>While hearing the Call Waiting tone</i> Terminating a current status  /  ►  <hr/> Holding a current status  ►  /  ► 	7	3	1	1	#	Set	7	3	1	0	#	Cancel	7	3	2	1	#	Set	7	3	2	0	#
7	3	1	1	#	Set																				
7	3	1	0	#	Cancel																				
7	3	2	1	#	Set																				
7	3	2	0	#	Cancel																				

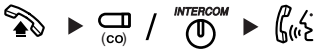
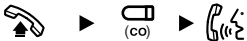
Features List

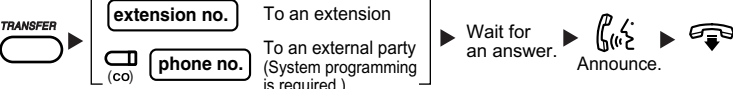
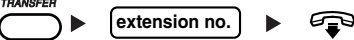
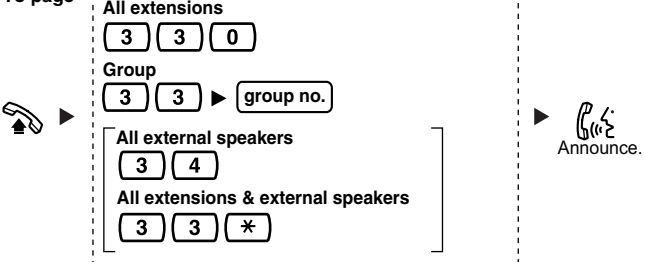
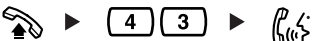
Desired Feature	Operation
During a Conversation	
Holding a call	<p>Holding</p>  <p>To retrieve a call at the holding extension</p> 
	<p>To retrieve an outside call from another extension</p> 
Holding a call exclusively	<p>Holding</p> 
	<p>To retrieve a call on exclusive hold</p> 
Transferring a call	<p>Screened</p>  <p>To an extension</p> <p>To an external party (System programming is required.)</p>
	<p>Unscreened to an extension</p> 
Useful Features	
Paging	<p>To page</p>  <p>All extensions 3 3 0</p> <p>Group 3 3 ▶ group no.</p> <p>All external speakers 3 4</p> <p>All extensions & external speakers 3 3 *</p> <p>Announce.</p>
	<p>To answer an announced page</p> 

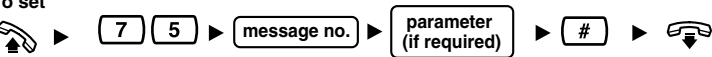
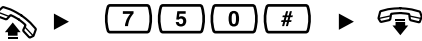
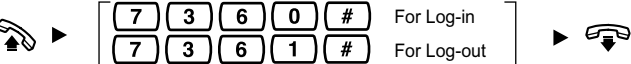
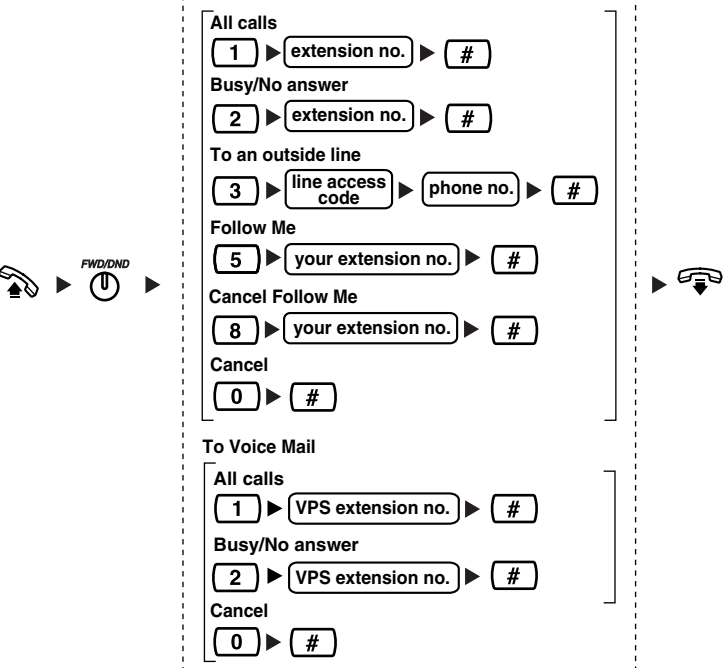

Features List

Desired Feature	Operation
Useful Features	
Three-party conference	
Setting Absent Message	<p>To set</p>  <hr style="border-top: 1px dashed black;"/> <p>To cancel</p> 
Log-in/Log-out	
Forwarding a call	

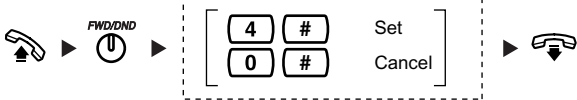
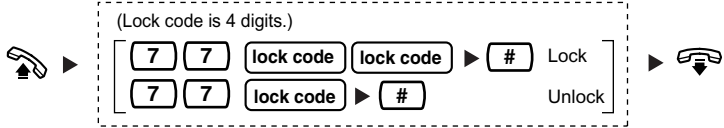
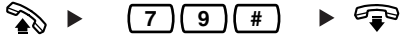
Features List

Desired Feature	Operation
Useful Features	
Do Not Disturb (DND)	
Locking your extension	<p>(Lock code is 4 digits.)</p> 
Clearing the setting	

Features List

Desired Feature	Operation	
Making Use of the Voice Mail Service		
Listening to a message	From your own extension	 ▶ <input data-bbox="505 293 647 325" type="text" value="VPS extension no."/> ▶ ▶ <input data-bbox="460 357 602 389" type="text" value="VPS password"/> <input data-bbox="613 357 647 389" type="text" value="#"/> <p>• If you have no password, you can skip the last step.</p>
	From someone else's extension	 ▶ <input data-bbox="505 552 647 584" type="text" value="VPS extension no."/> ▶ ▶ <input data-bbox="460 616 493 647" type="text" value="#"/> <input data-bbox="505 616 538 647" type="text" value="6"/> ▶ <input data-bbox="583 616 617 647" type="text" value="*"/> ▶ ▶ <input data-bbox="426 679 580 711" type="text" value="mailbox no."/> ▶ ▶ <input data-bbox="449 743 591 775" type="text" value="VPS password"/> <input data-bbox="602 743 636 775" type="text" value="#"/> <p>• If you have no password, you can skip the last step.</p>
Leaving a message	 ▶ <input data-bbox="393 979 535 1011" type="text" value="VPS extension no."/> ▶ <input data-bbox="580 979 613 1011" type="text" value="#"/> <input data-bbox="636 979 669 1011" type="text" value="6"/> ▶ ▶ <input data-bbox="337 1027 456 1059" type="text" value="mailbox no."/> / <input data-bbox="490 1027 524 1059" type="text" value="#"/> <input data-bbox="557 1027 591 1059" type="text" value="1"/> ▶ Enter the first 3 or 4 letters of the desired name ▶ ▶ Leave a message	
During playback	<input data-bbox="295 1155 329 1187" type="text" value="0"/> Repeat Voice Guidance <input data-bbox="295 1203 329 1235" type="text" value="*"/> Exit Menu	

- KX-TVA series**
 - Listen to Message
 - Deliver Message
 - Mailbox Management
 - Automated Attendant
 - Message Notification
 - Other Features
 - End Call
- KX-TVS series**
 - Listen to Message
 - Deliver Message
 - Check Mailbox Distribution
 - Automated Attendant
 - Mailbox Management
 - Other Features
 - End Call

Location of Controls



RINGER Volume/BACKLIGHT Illumination/Talking Caller ID Selector

LCD (Liquid Crystal Display) with Backlight

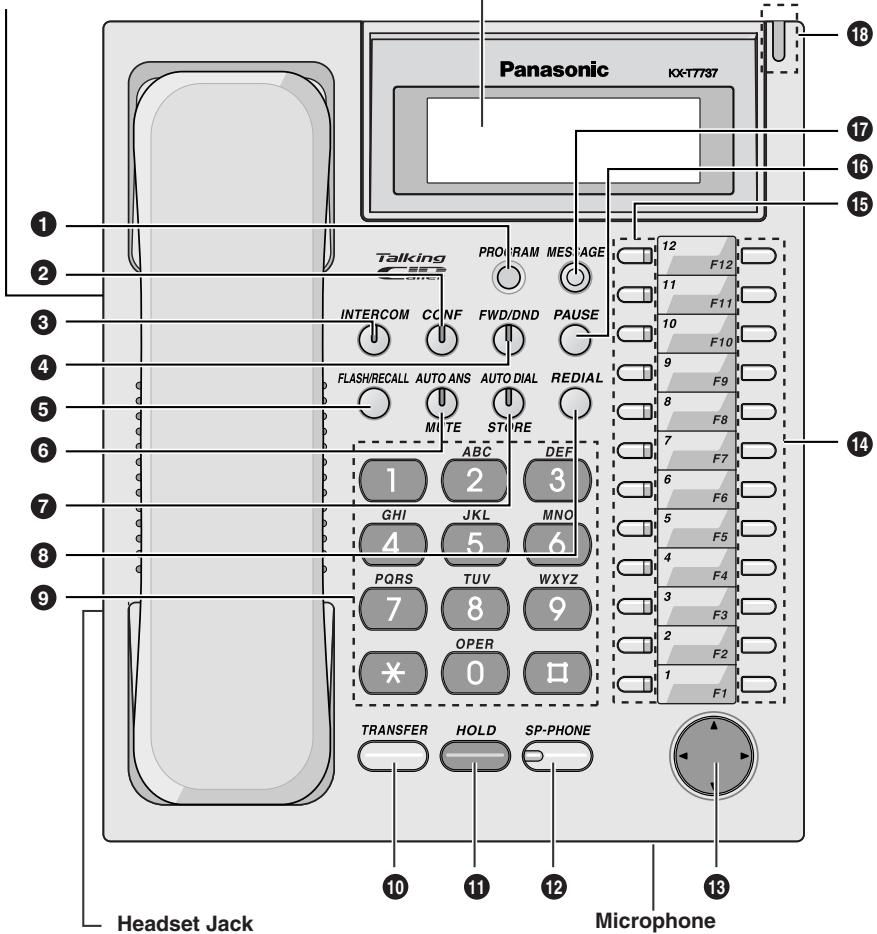

- * The KX-T7750 does not have a microphone.
- * The backlit display is only available on the KX-T7730/7731/7735/7736/7737.
- * The use of a headset is optional. Recommended headsets are KX-TCA91 and KX-TCA92.
- * The Talking Caller ID Selector is only available on the KX-T7737.

Location of Controls

- 1 PROGRAM:** Used to enter and exit the programming mode.
- 2 CONF (Conference):** Used to establish a multiple party conversation.
- 3 INTERCOM:** Used to make or receive intercom calls.
- 4 FWD/DND (Call Forwarding/Do Not Disturb):** Used to perform Call Forwarding or Do Not Disturb.
- 5 FLASH/RECALL:** Used for External Feature Access or to disconnect the current call and make another call without hanging up.
- 6 AUTO ANS (Auto Answer) (Other than KX-T7750):** Used to answer an incoming call in the hands-free mode.
MUTE (Other than KX-T7750): Used to mute the microphone during a conversation.
VOICE CALL (KX-T7750 only): Used to receive a notification via monitor in place of ringing.
- 7 AUTO DIAL/STORE:** Used for speed dialing or storing program changes.
- 8 REDIAL:** Used to redial.
- 9 DIALING BUTTONS WITH BACKLIGHT (KX-T7731/7736/7737):** Dialing buttons are backlit (1) when you receive a call, (2) during a conversation, (3) when BGM is activated at your phone, or (4) when you press any button.
- 10 TRANSFER:** Used to transfer a call to another party.
- 11 HOLD:** Used to place a call on hold.
- 12 SP-PHONE (Other than KX-T7750):** Used for the hands-free operation.
MONITOR (KX-T7750 only): Used for hands-free dialing. You can monitor the other party's voice hands-free.
- 13 NAVIGATOR KEY (KX-T7730/7731/7735/7736/7737):** Used to adjust the volume and the display contrast, or select desired items.
VOLUME KEY (KX-T7720/7750): Used to adjust the volume.
- 14 Programmable Feature (PF) Button:** Used as a One-touch Dialing button. (Button assignment is required.)
- 15 Flexible Outside (CO) Line Button:** Used to make or answer an outside call. Pressing this button seizes an idle outside line automatically. (Button assignment is required.) Also used as a feature button. (Button assignment is required.)
- 16 PAUSE:** Used to insert a pause during dialing.
- 17 MESSAGE:** Used to leave a message waiting indication, or call back the party who left the message waiting indication.
- 18 Message/Ringer Lamp:** The Message/Ringer lamp informs you visually that you have a message or a call.
 - When you receive a call, the lamp flashes depending on the ringing pattern. When the ringing pattern is set to Single (Slow flash), Double (Moderate flash), or Triple (Rapid flash) in your PBX, the lamp flashes accordingly. When any of the other ringing patterns are set in your PBX, the lamp may not flash. (e.g., S-Double, Call Waiting Tone1.)
 - When someone has left you a message, the lamp is lit continuously.



Before Operating the Telephone

◆ Speaker/Handset/Headset volume *

Speaker volume While in hands-free conversation	
Handset/Headset volume While using the handset or headset	

Press **Up** (Level increases) or **Down** (Level decreases).

◆ Ringer volume/Backlight illumination

	
---	---

Slide the lever of the **RINGER** Volume Selector and **BACKLIGHT** Illumination Selector to the desired setting.

BACKLIGHT SW POSITION	2	1	0
LCD backlight	HIGH	LOW	OFF
DIALING BUTTONS backlight	AUTO	AUTO	OFF

AUTO: The backlight shines only during operation.

◆ Display contrast *

KX-T7730/T731/T735/T736/T737



Press **Left** (Light) or **Right** (Dark).

* The above settings may return to default settings if the telephone line cord is disconnected, or the main unit's power is interrupted.

Before Operating the Telephone

◆ Talking Caller ID

KX-T7737

You can hear Caller ID information vocally sent from your PBX through the built-in speaker. The voice volume of Talking Caller ID depends on the setting of the Ringer volume. For the Ringer volume, refer to "**Ringer volume**" on page 10.



Slide the **TALK CID** Selector to ON to enable the Talking Caller ID feature.

Note: If the character ":" is included in the Caller ID name, it will not be announced normally. Therefore, we recommend that you do not use ":" in the Caller ID name.

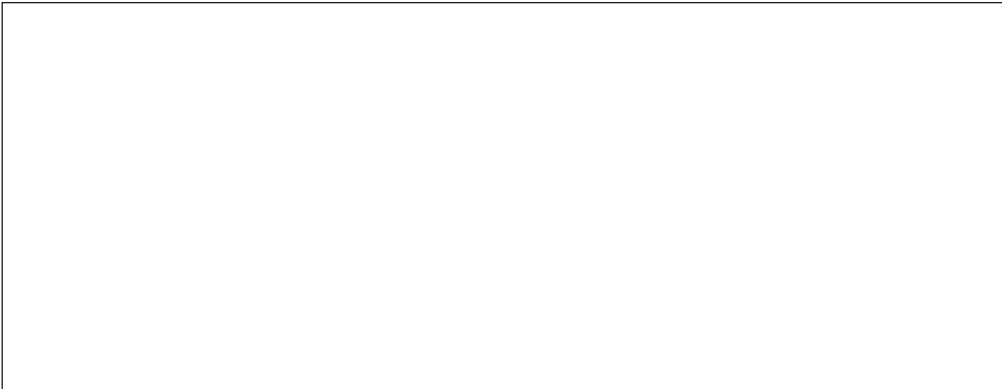

Panasonic Consumer Electronics Company,
Division of Panasonic Corporation of North America
One Panasonic Way, Secaucus, New Jersey 07094

Panasonic Puerto Rico, Inc.
San Gabriel Industrial Park, Ave. 65 de Infantería, Km. 9.5,
Carolina, Puerto Rico 00985

<http://www.panasonic.com/csd>

© 2005 Panasonic Communications Co., Ltd. All Rights Reserved.

PSQX3422WA KK0405ST3056